

Umlaufelement + Einzelschiene

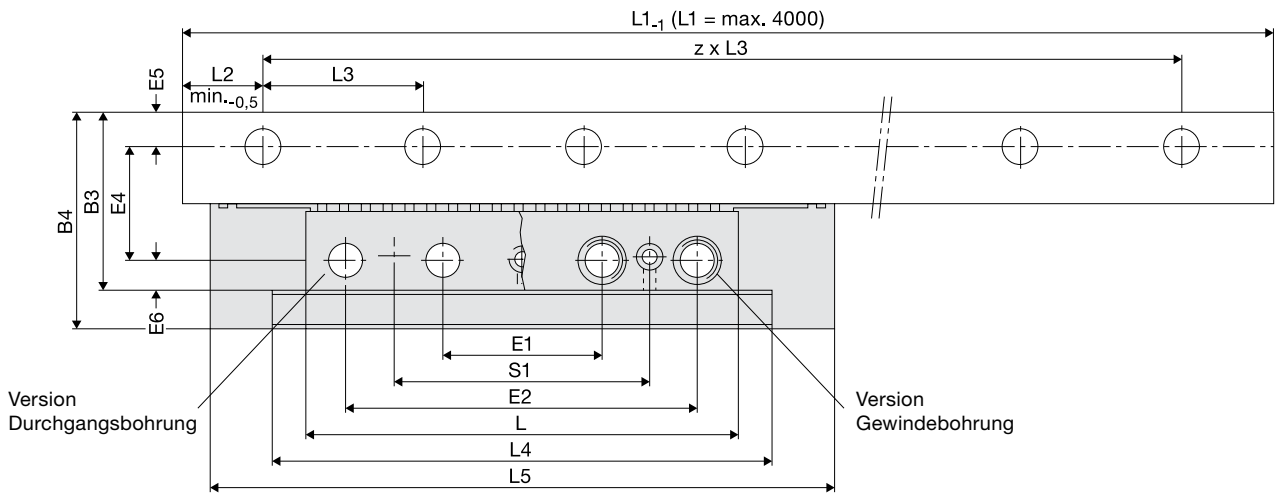

Typ FRA06E / FRA08E

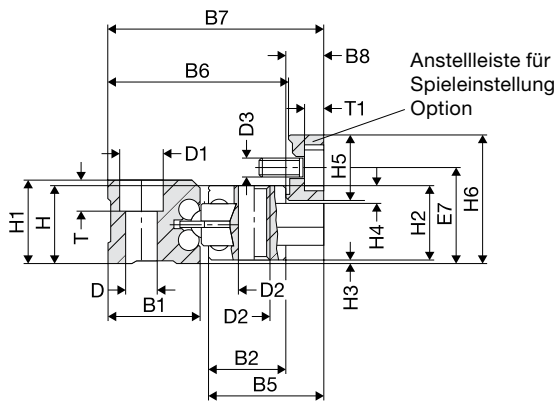

Typ FRA10E / FRA13E

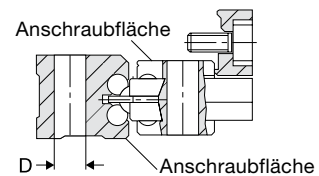

Schmierbohrungen

FRA06U / FRA08U mit Durchgangsbohrung

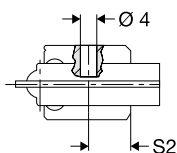

FRA10U / FRA13U mit Durchgangsbohrung

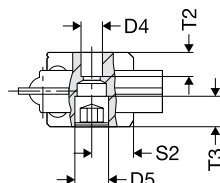

FRA06U / FRA13U mit Gewindebohrung

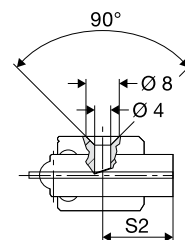

Werkstoffe

	Grundkörper	Wälzkörper	Abstreifer
Standard	hochfestes, eloxiertes Aluminium Stahl Zinkdruckguss	Wälzlagerstahl	integrierte Filzabstreifer

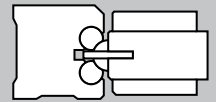

Abmessungen Einzelschiene

Größe	Abmessungen																
	mm																
	H	B1	B3	B4	B6	B7	D	D1	E4	E5	E7	H1	H3	H6	L2	L3	T
FRA06E	16,0	20,0	36,5	44,5	38,0	44,5	5,5	10	24,5	7,0	20,7	16,7	1,0	27,7	25	50	7,0
FRA08E	21,0	26,3	47,3	57,3	48,8	57,3	6,6	11	31,8	8,5	26,0	22,2	1,0	32,5	50	100	8,5
FRA10E	23,8	24,4	51,4	63,0	51,4	62,9	9,0	-	31,4	10,0	29,4	25,0	1,0	39,4	50	100	-
FRA13E	31,2	31,6	65,1	89,5	65,1	80,1	12,0	-	41,1	12,0	37,2	33,0	1,2	48,7	50	100	-

Abmessungen Umlaufelement

Größe	Abmessungen																				
	mm																				
	B2	B5	B8	D2	D3	D4	D5	E1	E2	E6	H2	H4	H5	L	L4	L5	S1	S2	T1	T2	T3
FRA06UD	15,0	23,1	8,0	6,0	M05	-	-	25	70	5	15,0	3,0	14,0	82,0	82	124	-	5,0	4,0	-	-
FRA06UM	15,0	23,1	8,0	M06	M05	-	-	25	70	5	15,0	3,0	14,0	82,0	82	124	50	7,0	4,0	-	-
FRA08UD	19,5	29,5	10,0	6,6	M06	-	-	32	84	7	20,0	5,0	15,5	100,0	104	153	-	7,0	4,8	-	-
FRA08UM	19,5	29,5	10,0	M08	M06	-	-	32	84	7	20,0	5,0	15,5	100,0	104	153	58	9,5	4,8	-	-
FRA10UD	24,4	36,0	11,5	9,0	M06	M06	M06	50	110	10	22,8	5,4	20,0	134,2	155	194	-	10,0	6,0	9,0	9,0
FRA10UM	24,4	36,0	11,5	M10	M06	-	-	50	110	10	22,8	5,4	20,0	134,2	155	194	80	11,0	6,0	-	-
FRA13UD	31,6	56,0	15,0	11,0	M08	M05	G1/8	60	140	12	30,0	7,6	23,0	169,0	178	242	-	12,0	8,0	8,0	12,0
FRA13UM	31,6	56,0	15,0	M12	M08	-	-	60	140	12	30,0	7,6	23,0	169,0	178	242	100	15,0	8,0	-	-

Tragzahlen, Gewicht

Größe	Tragzahlen		Gewicht		
	N	Co	Umlaufelement/Stück	kg	
	C	Co		Schiene/m	
FRA06UD	24200	37300	0,2	0,7	mit Durchgangsbohrung
FRA06UM	24200	37300	0,2	0,7	mit Gewindebohrung
FRA08UD	38200	58300	0,4	1,2	mit Durchgangsbohrung
FRA08UM	38200	58300	0,4	1,2	mit Gewindebohrung
FRA10UD	62000	85400	0,8	1,9	mit Durchgangsbohrung
FRA10UM	62000	85400	0,8	1,9	mit Gewindebohrung
FRA13UD	103100	137700	1,7	2,9	mit Durchgangsbohrung
FRA13UM	103100	137700	1,7	2,9	mit Gewindebohrung

Bestellnummern

Best.-Nr.	Bestellschlüssel
Umlaufelement	Einzelschiene
80587A	z.B. FRA06E1500
80545A	
80588A	
80546A	
80589A	
80547A	
80590A	
80548A	

**Führungsschienen bis 4000 mm an einem Stück. Längere Hubstrecken werden gekoppelt.